



KATALOG CZĘŚCI ZAMIENNYCH
WODOMIERZY SPRZEŻONYCH TYPU
MWN/JS-S, MWN/JS-S- NK
Z ZAWOREM SPRĘŻYNOWYM NKP
MID

SPARE PART CATALOGUE
OF THE **MWN/JS-S, MWN/JS-S-** NK
- TYPE COMPOUND WATER METERS NKP
SPRING-WEIGHTED VALVE
MID

ERSATZTEILEKATALOG
MWN/JS-S, MWN/JS-S- NK
- VERBUNDWASSERZÄHLER NKP
MIT FEDERVENTIL
MID

Nr 580

2014

**Produkcja wodomierzy sprzężonych
typu MWN/JS-S, MWN/JS-S-^{NK}_{NKP}
Manufacturing of the MWN/JS-S, MWN/JS-S-^{NK}_{NKP}
type compound water meters
Produktion der Verbundwasserzähler Bauart
MWN/JS-S, MWN/JS-S-^{NK}_{NKP}**

Wodomierz Water-meter Wasserzähler	Produkcja od roku Production from the Year Production ab Jahr
MWN/JS 50/4,0-S MWN/JS 65/4,0-S MWN/JS 80/4,0-S MWN/JS 100/4,0-S MWN/JS 150/16-S	2011

Warunki dostawy:

Zamówienia w 2-u egzemplarzach winny zawierać:

1. Nazwę i numer części
2. Ilość sztuk
3. Średnicę i typ wodomierza

Delivery conditions :

When ordering please specify:

1. Quantity of parts
2. Designation and part - No
3. Size and type of watermeter

Lieferungs Bedingungen:

Bei der Bestellung bitten wir anzugeben:

1. Stückzahl der Ersatzteile
2. Benennung und Teil - Nr
3. Zähler - Nenngrosse in mm

Dostawca:

Liferant:

Supplier:





ul. Klemensa Janickiego 23/25
60-542 Poznań



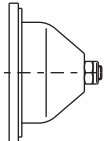

Fax: +48 61 8472548

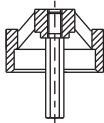
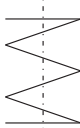

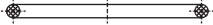
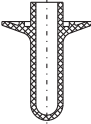
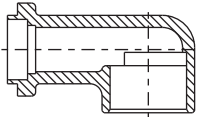
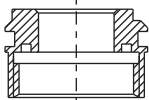
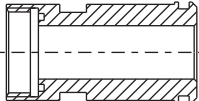
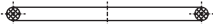
Tel. +48 61 8418136
+48 61 8418138
+48 61 8418148

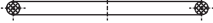
e-mail : handel@powogaz.com.pl

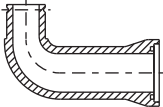
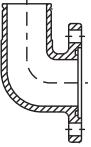
Lp.	Nazwa części lub zespołu Designation of the part Teil Benennung	Numer katalogowy Catalogue - No. Katalog - Nr					Szkiec Sketch Skizze
		MWN/JS 50/4,0-S MWN/JS 50/4,0-S- ^{NK} _{NKP}	MWN/JS 65/4,0-S MWN/JS 65/4,0-S- ^{NK} _{NKP}	MWN/JS 80/4,0-S MWN/JS 80/4,0-S- ^{NK} _{NKP}	MWN/JS 100/4,0-S MWN/JS 100/4,0-S- ^{NK} _{NKP}	MWN/JS 150/16-S MWN/JS 150/16-S- ^{NK} _{NKP}	
1	Wodomierz główny Mein water meter Hauptzähler	Wodomierz MWN - części zamienne wg katalogu Nr 539 Wodomierz MWN-^{NK}_{NKP} - części zamienne wg katalogu Nr 542				wg kat. Nr 563 wg kat. Nr 564	
2	Wodomierz boczny By-pass water meter Nebenzähler	Wodomierz JS - części zamienne wg katalogu Nr 543 Wodomierz JS-^{NK}_{NKP} - części zamienne wg katalogu Nr 541				wg kat. Nr 569 wg kat. Nr 578	
3	Wstawka zaworu Velve insert cpl. Ventileinsatz Kompl.	7310	7311	7311	7312	7313	
4	Podkładka uszczelniająca Packing washer Dichtring	7340 107x56x3	7344 165x85x3	7341 142x89x3	7342 162x109x3	7343 212x159x3	
5	Uchwyt kpl. Holder cpl. Vesthaltesatz	7345	7345	7345	7345	7346	
6	Sprężyna Spring Druckfeder	7348	7348	7348	7348	7348	

Lp.	Nazwa części lub zespołu Designation of the part Teil Benennung	Numer katalogowy Catalogue - No. Katalog - Nr					Szkic Sketch Skizze
		MWN/JS 50/4,0-S MWN/JS 50/4,0-S- ^{NK} _{NKP}	MWN/JS 65/4,0-S MWN/JS 65/4,0-S- ^{NK} _{NKP}	MWN/JS 80/4,0-S MWN/JS 80/4,0-S- ^{NK} _{NKP}	MWN/JS 100/4,0-S MWN/JS 100/4,0-S- ^{NK} _{NKP}	MWN/JS 150/16-S MWN/JS 150/16-S- ^{NK} _{NKP}	
7	Pierścień uszczelniający - EPDM Packing ring - EPDM Dichtungsring - EPDM	7390 34x3	7390 34x3	7390 34x3	7390 34x3	11659 40x3	
8	Grzybek zaworu Valve plate Ventilteller	7338	7338	7338	7338	7339	
9	Łącznik tylny Back connector Hinterverbinder	7330	7330	7330	7330	7331	
10	Nakrętka specjalna Special nut Spezielle Mutter	7332	7332	7332	-	7333	
11	Łącznik kompensacyjny G1 Compensative connector G1 Compensationsverbinder	-	-	-	7334	-	
12	Pierścień uszczelniający - EPDM Packing ring - EPDM Dichtungsring - EPDM	7391 32x3	7391 32x3	7391 32x3	7391 32x3	7392 60x5	

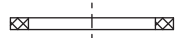
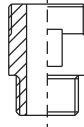
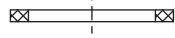
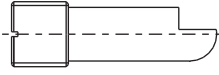
Lp.	Nazwa części lub zespołu Designation of the part Teil Benennung	Numer katalogowy Catalogue - No. Katalog - Nr					Szkiec Sketch Skizze
		MWN/JS 50/4,0-S MWN/JS 50/4,0-S- ^{NK} _{NKP}	MWN/JS 65/4,0-S MWN/JS 65/4,0-S- ^{NK} _{NKP}	MWN/JS 80/4,0-S MWN/JS 80/4,0-S- ^{NK} _{NKP}	MWN/JS 100/4,0-S MWN/JS 100/4,0-S- ^{NK} _{NKP}	MWN/JS 150/16-S MWN/JS 150/16-S- ^{NK} _{NKP}	
13	Pierścień uszczelniający - EPDM Packing ring - EPDM Dichtungsring - EPDM	7393 25x2,5	7393 25x2,5	7393 25x2,5	7393 25x2,5	7394 50x3	
14	Kołnierz Flange Flansch	7335	7335	7335	7335	7336	
15	Kolanko Knee-piece Bogen	7321	7321	7321	7321	-	
16	Łącznik dopływowy Inflow connector Zuflußverbinder	-	-	-	-	7322	
17	Nakrętka Nut Mutter	7323 G ³ / ₄	7323 G ³ / ₄	7323 G ³ / ₄	7323 G ³ / ₄	7324 G ¹ / ₂	
18	Pierścień osadczy Settling ring Stelling	7325	7325	7325	7325	7326	

Lp.	Nazwa części lub zespołu Designation of the part Teil Benennung	Numer katalogowy Catalogue - No. Katalog - Nr					Szkiec Sketch Skizze
		MWN/JS 50/4,0-S MWN/JS 50/4,0-S- ^{NK} _{NKP}	MWN/JS 65/4,0-S MWN/JS 65/4,0-S- ^{NK} _{NKP}	MWN/JS 80/4,0-S MWN/JS 80/4,0-S- ^{NK} _{NKP}	MWN/JS 100/4,0-S MWN/JS 100/4,0-S- ^{NK} _{NKP}	MWN/JS 150/16-S MWN/JS 150/16-S- ^{NK} _{NKP}	
19	Podkładka uszczelniająca Packing washer Dichtring	7315 24x15x2	7315 24x15x2	7315 24x15x2	7315 24x15x2	7316 45x34x2,5	
20	Króciec Staub pipe Rohrstutzen	7318	7317	7317	7317	7319	
21	Podkładka uszczelniająca Packing washer Dichtring	7305 27,5x21x2	7305 27,5x21x2	7305 27,5x21x2	7305 27,5x21x2	7306 41x34x2,5	
22	Wkrętka Screw plug Muffe	7347	-	-	-	-	
23	Pierścień uszczelniający - EPDM Packing ring - EPDM Dichtungsring - EPDM	-	-	-	-	7328 204x8	
24	Korek Plug Stopfen	7417 G ¹ / ₂	7417 G ¹ / ₂	7417 G ¹ / ₂	7417 G ¹ / ₂	7418 G 1	

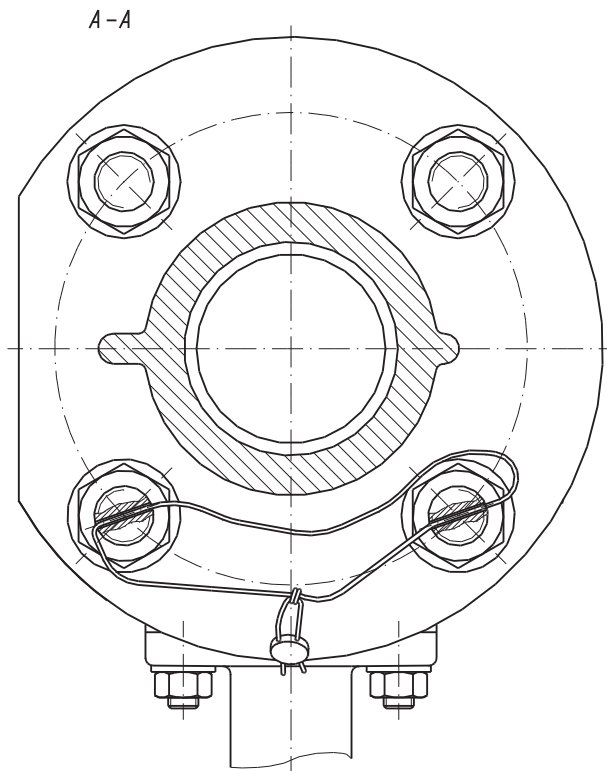
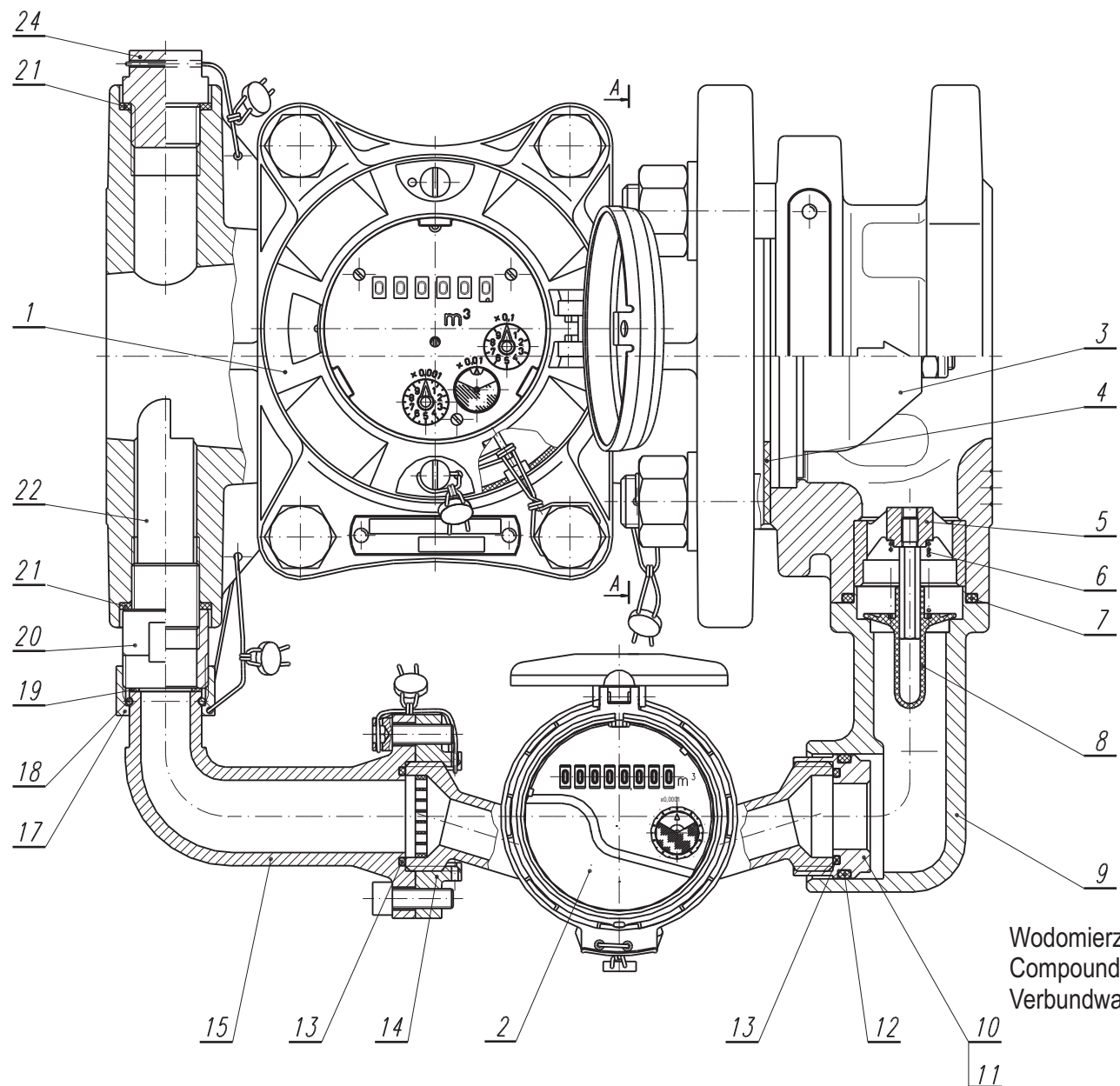

Wodomierz sprzężony
Compound water meters
Verbundwasserzähler

- MWN/JS 50/4,0-S, MWN/JS 50/4,0-S- NK
NKFP
- MWN/JS 65/4,0-S, MWN/JS 65/4,0-S- NK
NKFP
- MWN/JS 80/4,0-S, MWN/JS 80/4,0-S- NK
NKFP
- MWN/JS 100/4,0-S, MWN/JS 100/4,0-S- NK
NKFP

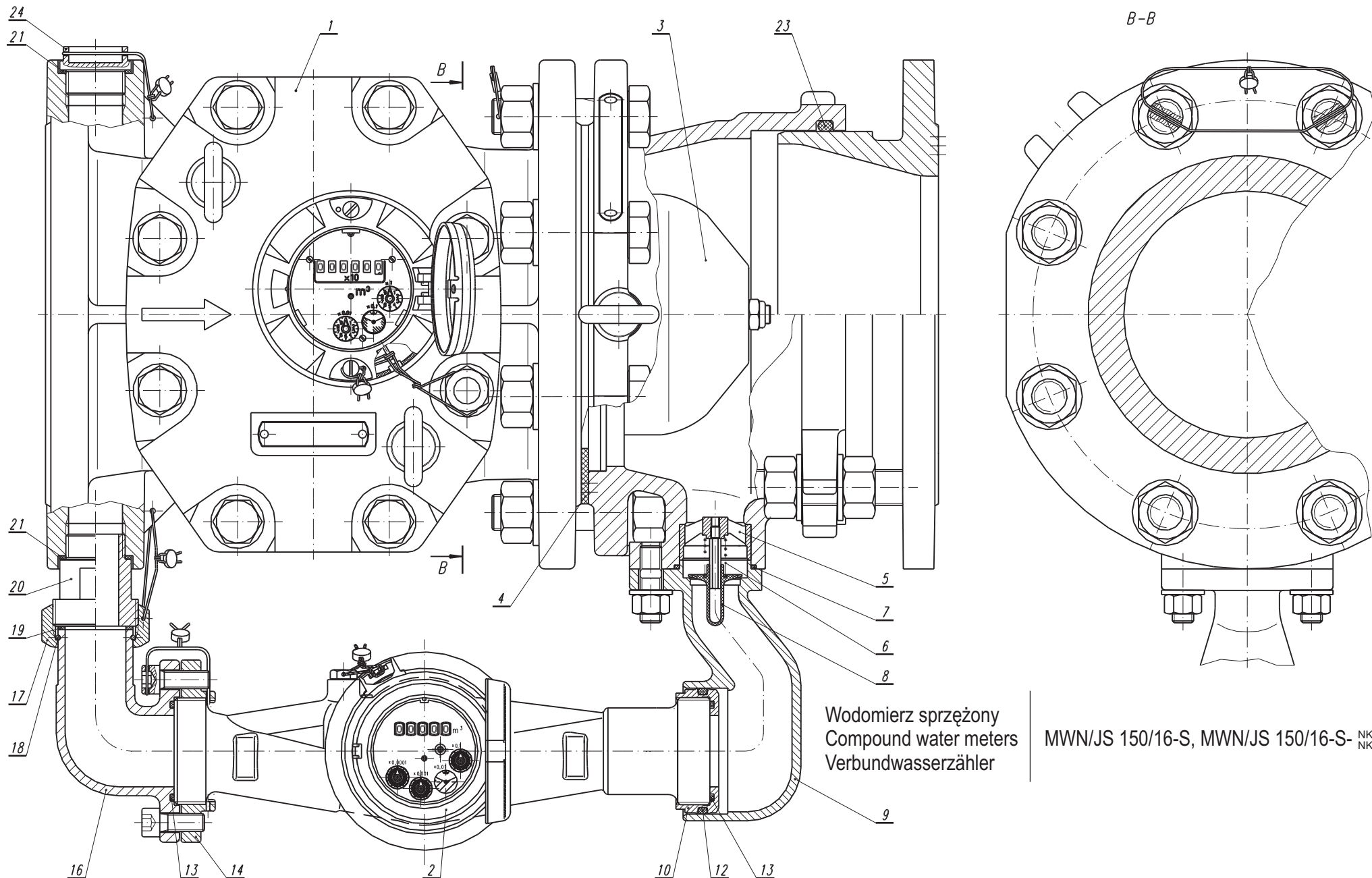

Wodomierz sprzężony
Compound water meters
Verbundwasserzähler

MWN/JS 150/16-S, MWN/JS 150/16-S-
NK
NKP